

SFP-B1023L-20

Optical SFP Module

10Gbps SFP+ Transceiver Bi-Di TX1270/RX1330nm 20KM LC



Features

- Supports up to 10.7Gbps bit rates
- 1270nm DFB laser and PIN photodiode, Up to 20km for SMF transmission
- Compliant with SFP+ MSA and SFF-8472 with single LC receptacle
- Hot-pluggable SFP+ footprint
- Real Time Digital Diagnostic Monitoring
- Single +3.3V power supply
- Compatible with RoHS
- Operating case temperature:
Standard: 0 to +70° C
Industrial: -40 to +85° C

Application

- 10Gbps Optical systems
- 10GBASE-LR at 10.3125Gbps
- 10GBASE-LW at 9.953Gbps
- LTE systems
- Other Optical links

Standard

- Compliant with MSA SFP specification(SFF-8431, SFF-8432, SFF-8472)
- Compliant with IEC
- Compliant with IEEE 802.3ae

Description

The SFP+ transceivers are high performance, cost effective modules supporting data rate of 10Gbps and 20km transmission distance with SMF.

The transceiver consists of three sections: a DFB laser transmitter, a PIN photodiode integrated with a trans-impedance preamplifier (TIA) and MCU control unit. All modules satisfy class I laser safety requirements.

The transceivers are compatible with SFP Multi-Source Agreement and SFF-8472 digital diagnostics functions.

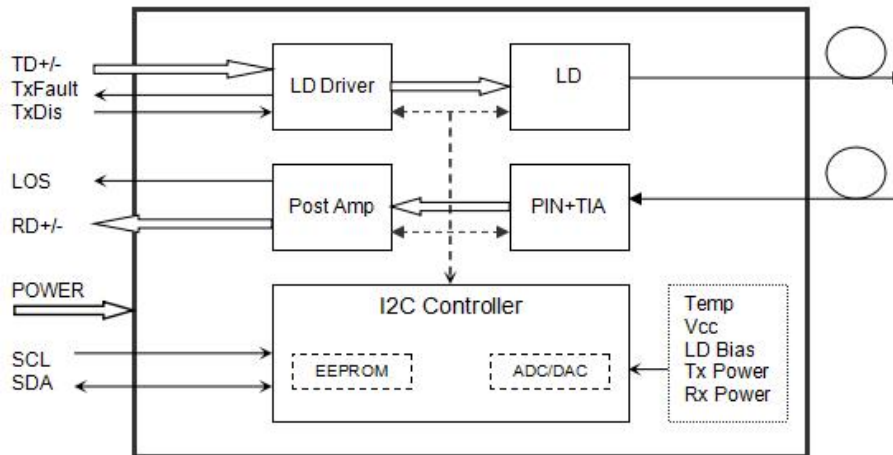

Absolute Maximum Ratings

Parameter	Symbol	Min	Max	Unit
Supply Voltage	Vcc	-0.3	4	V
Storage Temperature	Ts	-40	+85	°C
Operating Humidity	-	5	85	%

Recommended Operating Conditions

Parameter		Symbol	Min	Typical	Max	Unit
Operating Case Temperature	Standard	T _c	0		+70	°C
	Industrial		-40		+85	°C
Power Supply Voltage		V _{cc}	3.135	3.30	3.465	V
Power Supply Current		I _{cc}		270	350	mA
Data Rate				10.3	11.3	Gbps
Transmission Distance				20		km

Optical and Electrical Characteristics

Parameter		Symbol	Min	Typical	Max	Unit	Notes
Transmitter							
Centre Wavelength		λ_c	1260	1270	1280	nm	
Side-Mode Suppression Ratio		SMSR	30	-		dB	
Average Output Power		P _{out}	-6		-1	dBm	1
Extinction Ratio		ER	3.5			dB	
Data Input Swing Differential		V _{IN}	180		700	mV	2
Input Differential Impedance		Z _{IN}	85	100	115	Ω	
TX Disable	Disable		2.4		V _{cc}	V	
	Enable		-0.3		0.8	V	
TX Fault	Fault		2.0		V _{cc} +0.3	V	
	Normal		-0.3		0.8	V	
Receiver							
Centre Wavelength		λ_c	1320	1330	1340	nm	
Receiver Sensitivity					-14.4	dBm	3
Receiver Overload			0.5			dBm	3
LOS De-Assert		LOS _D			-17	dBm	
LOS Assert		LOS _A	-30			dBm	
LOS Hysteresis			0.5		5	dB	
Data Output Swing Differential		V _{out}	300		850	mV	4
LOS	Fault		2		V _{cc} Host	V	
	Norm		-0.3		+0.4	V	

Notes:

1. The optical power is launched into SMF.
2. PECL input, internally AC-coupled and terminated.
3. Measured with a PRBS 2³¹-1 test pattern @10312Mbps, BER ≤1×10⁻¹².
4. Internally AC-coupled.

Timing and Electrical

Parameter	Symbol	Min	Typical	Max	Unit
Tx Disable Negate Time	t_on			1	ms
Tx Disable Assert Time	t_off			10	μs
Time To Initialize, including Reset of Tx Fault	t_init			300	ms
Tx Fault Assert Time	t_fault			100	μs
Tx Disable To Reset	t_reset	10			μs
LOS Assert Time	t_loss_on			100	μs
LOS De-assert Time	t_loss_off			100	μs
Serial ID Clock Rate	f_serial_clock		100	400	KHz
MOD_DEF (0:2)-High	V _H	2		V _{cc}	V
MOD_DEF (0:2)-Low	V _L			0.8	V

Diagnostics

Parameter	Range	Unit	Accuracy	Calibration
Temperature	0 to +70	°C	±3°C	Internal
	-40 to +85			
Voltage	3.0 to 3.6	V	±3%	Internal
Bias Current	0 to 100	mA	±10%	Internal
TX Power	-6.5 to +2	dBm	±3dB	Internal
RX Power	-17 to +1	dBm	±3dB	Internal

Digital Diagnostic Memory Map

The transceivers provide serial ID memory contents and diagnostic information about the present operating conditions by the 2-wire serial interface (SCL, SDA).

The diagnostic information with internal calibration or external calibration all are implemented, including received power monitoring, transmitted power monitoring, bias current monitoring, supply voltage monitoring and temperature monitoring.

The digital diagnostic memory map specific data field defines as following.

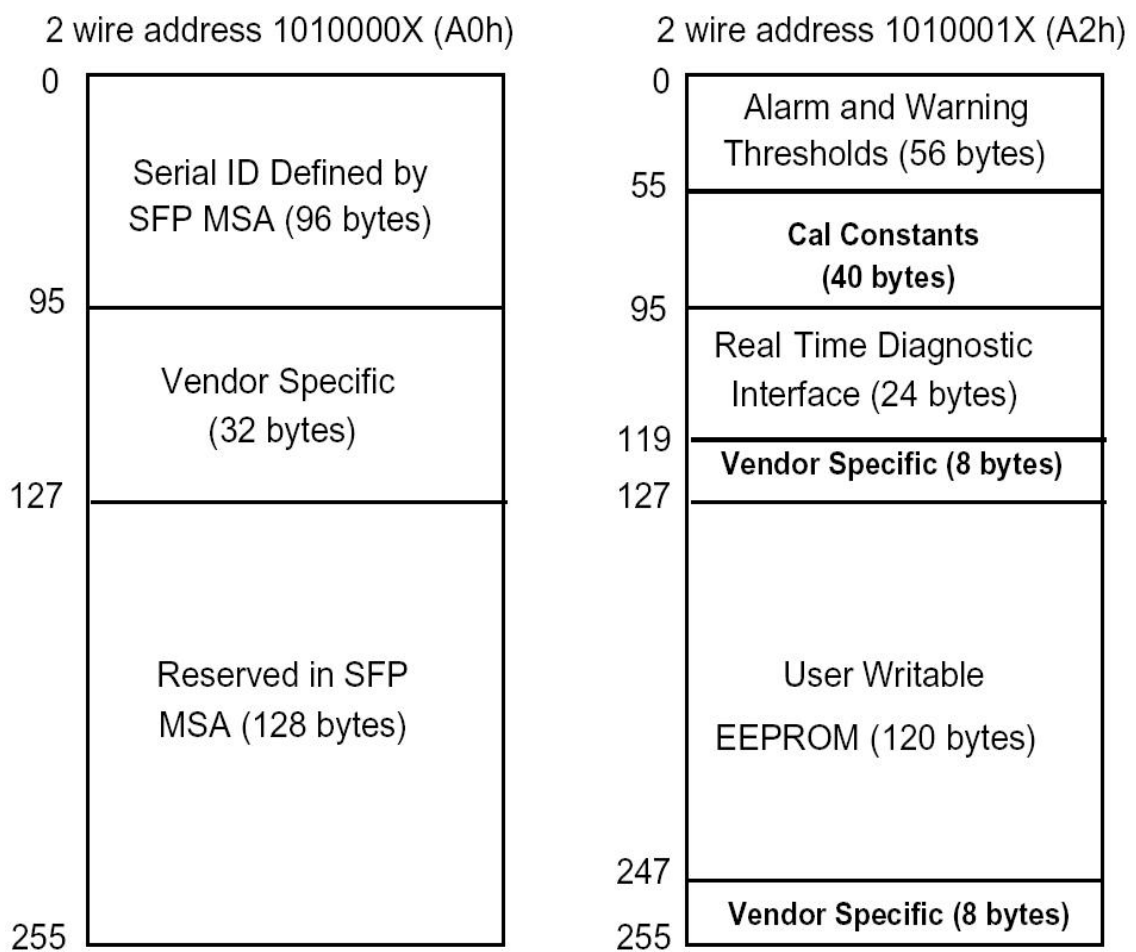

Pin Description

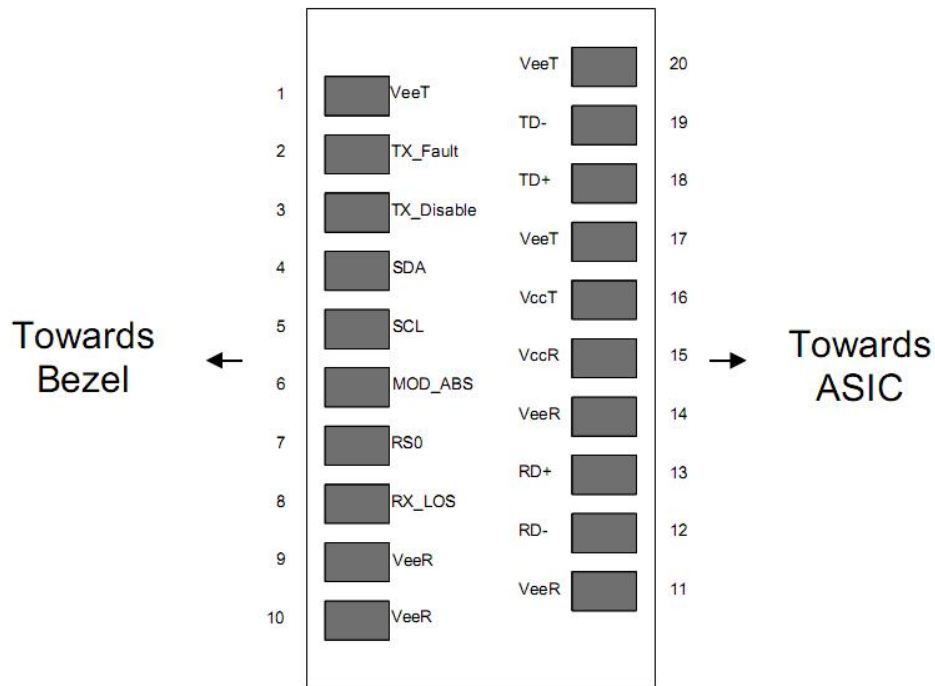

Pin	Signal Name	Description	Plug Seq.	Notes
1	V _{EET}	Transmitter Ground	1	
2	TX_FAULT	Transmitter Fault Indication	3	Note 1
3	TX_DISABLE	Transmitter Disable	3	Note 2
4	SDA	SDA Serial Data Signal	3	
5	SCL	SCL Serial Clock Signal	3	
6	MOD_ABS	Module Absent. Grounded within the module	3	
7	RS0	Not Connected	3	
8	LOS	Loss of Signal	3	Note 3
9	V _{EER}	Receiver ground	1	
10	V _{EER}	Receiver ground	1	
11	V _{EER}	Receiver ground	1	
12	RD-	Inv. Received Data Out	3	Note 4
13	RD+	Received Data Out	3	Note 4
14	V _{EER}	Receiver ground	1	
15	V _{CCR}	Receiver Power Supply	2	
16	V _{CCT}	Transmitter Power Supply	2	
17	V _{EET}	Transmitter Ground	1	
18	TD+	Transmit Data In	3	Note 5
19	TD-	Inv. Transmit Data In	3	Note 5
20	V _{EET}	Transmitter Ground	1	

Notes:

Plug Seq.: Pin engagement sequence during hot plugging.

- 1) TX Fault is an open collector output, which should be pulled up with a 4.7k~10kΩ resistor on the host board to a voltage between 2.0V and Vcc+0.3V. Logic 0 indicates normal operation; Logic 1 indicates a laser fault of some kind. In the low state, the output will be pulled to less than 0.8V.
- 2) Laser output disabled on TDIS >2.0V or open, enabled on TDIS <0.8V.
- 3) LOS is open collector output. Should be pulled up with 4.7k~10kΩ on host board to a voltage between 2.0V and 3.6V. Logic 0 indicates normal operation; logic 1 indicates loss of signal.
- 4) RD-/+ : These are the differential receiver outputs. They are internally AC-coupled 100 differential lines which should be terminated with 100Ω (differential) at the user SERDES.
- 5) TD-/+ : These are the differential transmitter inputs. They are internally AC-coupled, differential lines with 100Ω differential termination inside the module.

Recommended Interface Circuit

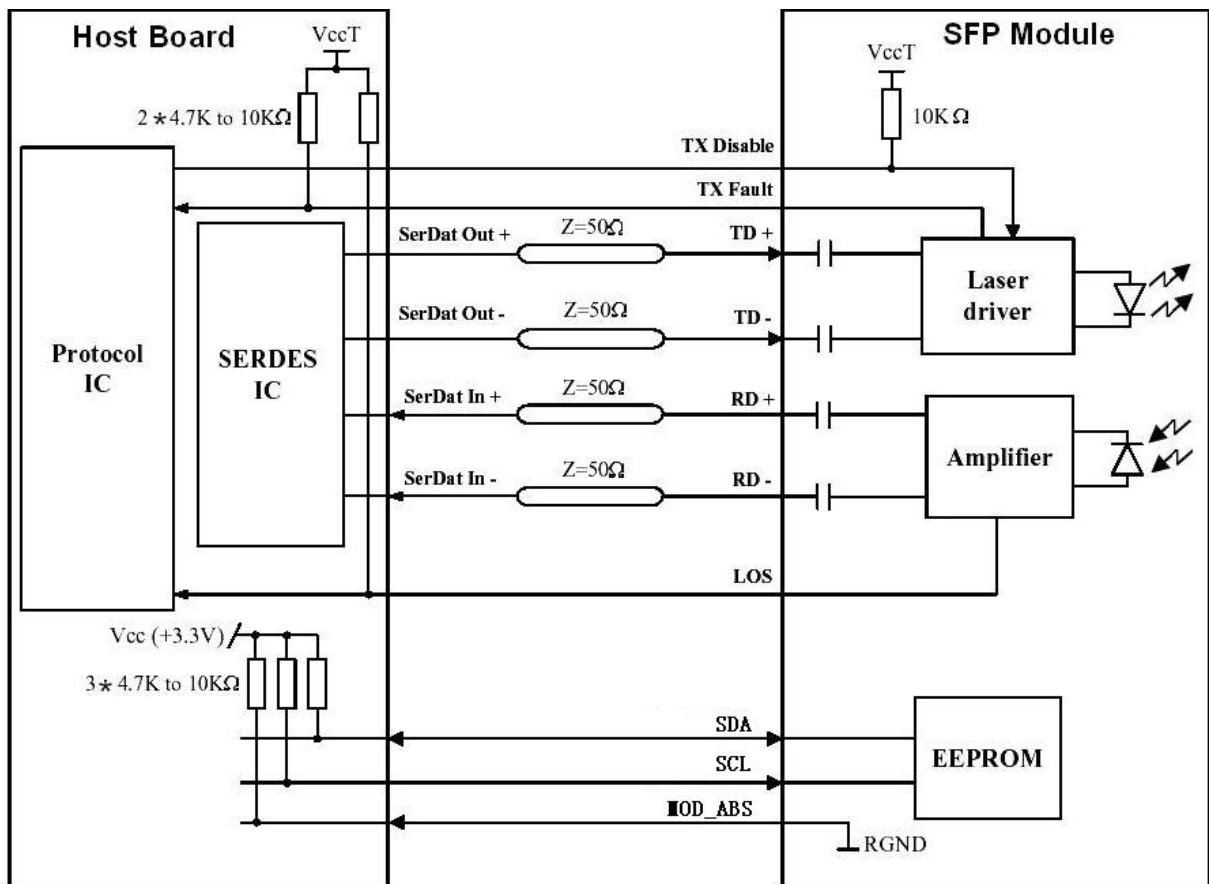

Mechanical Dimensions

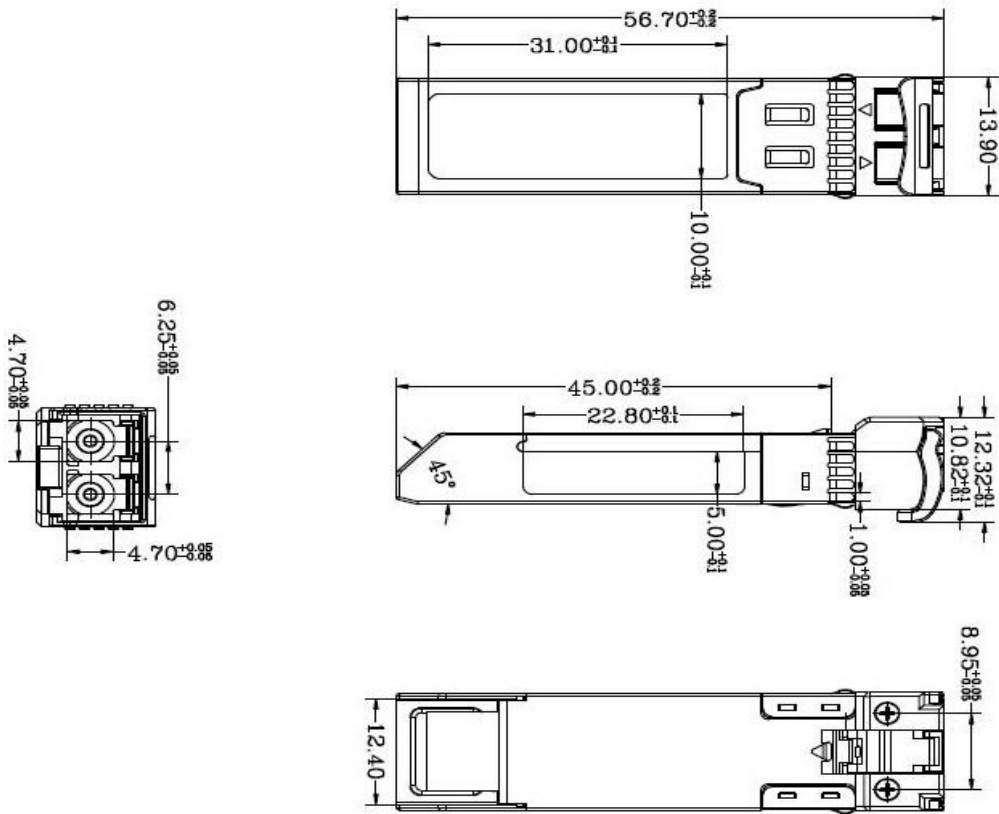

Ordering information

Model No.	Product Description
SFP-B1023L-20	10Gbps, TX1270/RX1330, LC, 20km, 0°C~+70°C, with DDM
SFP-B1023L-20I	10Gbps, TX1270/RX1330, LC, 20km, -40°C~+85°C, with DDM



For further information, please visit our website <https://www.aoatech.com>

All rights are reserved by AOA Technology Co.,Ltd. AOA reserves the right to change, modify, transfer, or otherwise revise this publication without notice, and the most current version of the publication shall be applicable.